

Leuchtenteile, LED-Module, Optiken, Zubehör

Für Zusammenbau, Montage etc. in Eigenregie übernehmen wir keine Verantwortung

Luminaire parts, LED modules, Optics, Accessories

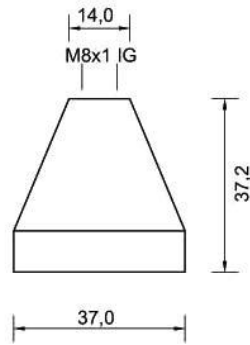

Farb-Codes: **87** **92**

für optische Linse for optical lens	Artikelnummer ref.-No.
K53-553-403-00 + K53-553-405-00	K53-553-455-..

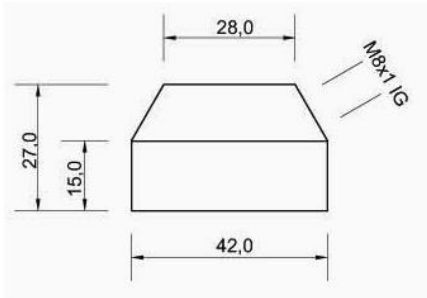

Farb-Codes: **40** **87**

für optische Linse for optical lens	Artikelnummer ref.-No.
K53-553-401-00	K53-553-453-..

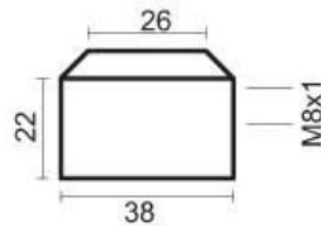

Farb-Codes: **40** **87**

für optische Linse for optical lens	Artikelnummer ref.-No.
K53-553-403-00 + K53-553-405-00	K53-553-454-..

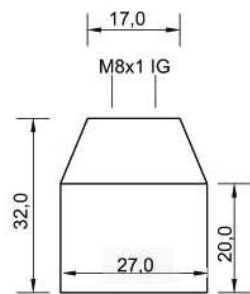

Farb-Codes: **40** **87**

für optische Linse for optical lens	Artikelnummer ref.-No.
K53-553-404-00 + K53-553-406-00	K53-553-452-..

Flexschlauch
flexible tube



Farb-Codes: **40** **87**

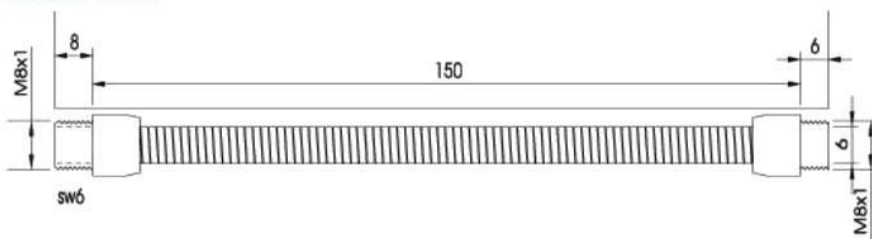

Länge length	Artikelnummer ref.-No.
150 mm	Flex090150-..
200 mm	Flex090200-..
300 mm	Flex090300-..

Farben: **40** = Messing natur, **87** = silberfarbig lackiert, **92** = Aluminium natur
Colors: **40** = bronze, **87** = silver painted, **92** = Aluminium nature

K05.3-01

simpled

Lösungen mit Licht
Markt 12 D-49497 Mettingen
Fon (+49) 05452 9188 53
Fax (+49) 05452 9188 52
info@simpled.de
www.simpled.de

Optiken für Seoul P4 und Luxeon 1 LED
Optics for Seoul P4 and Luxeon 1 LED

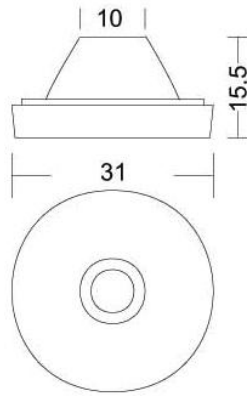

Abstrahlwinkel 10°
 beam angle 10°

K53-553-403-00

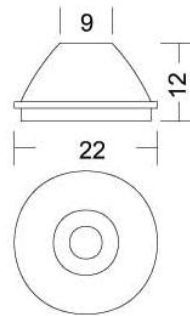

Abstrahlwinkel 10°
 beam angle 10°

K5-553-404-00

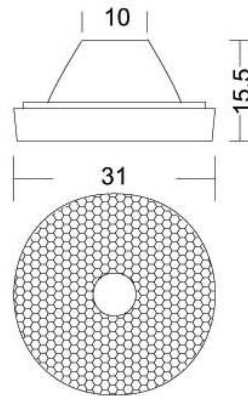

Abstrahlwinkel 30°
 beam angle 30°

K53-553-405-00

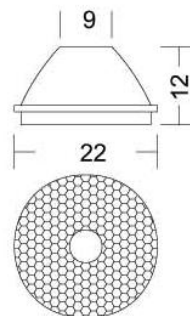
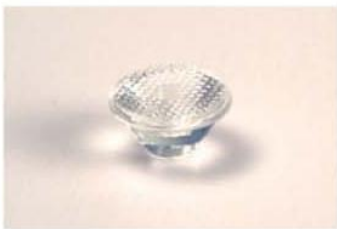

Abstrahlwinkel 30°
 beam angle 30°

K53-553-406-00

Aluminium-Kühlkörper und Wärmeleit-Klebeband Aluminium heatsinks and thermal conducting tape

Artikelbezeichnung article description	Gewicht weight	Artikelnummer ref.-No.
Aluminium-Kühlkörper aus Kokillenguß aluminium heatsink, chill-casted	97 g	K53-556-990-92

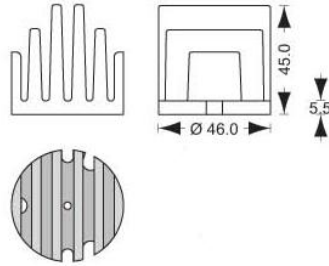

Artikelbezeichnung article description	Gewicht weight	Artikelnummer ref.-No.
Aluminium-Stiftkühlkörper aluminium heatsink with pins	14 g	K53-556-993-92

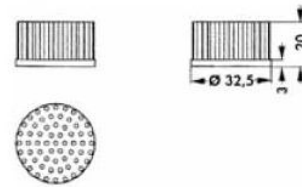

Artikelbezeichnung article description	Gewicht weight	Artikelnummer ref.-No.
Aluminium-Stiftkühlkörper aluminium heatsink with pins	21 g	K53-556-994-92

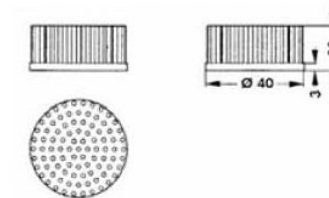

Artikelbezeichnung article description	Gewicht weight	Artikelnummer ref.-No.
Aluminium-Stiftkühlkörper aluminium heatsink with pins	31 g	K53-556-995-92

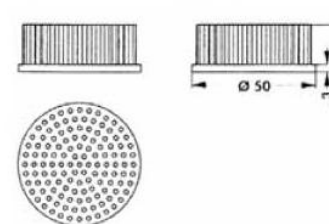

Artikelbezeichnung article description	Artikelnummer ref.-No.
wärmeleitfähiges, doppelseitiges Klebeband 3M Nr. 8940, sw 20 mm, zum Aufkleben von LUXEON Star LED auf Metallkühlkörper 132 St. / Bogen (DIN A4) thermal conducting doubleside adhesive tape 3M No. 8940 hexagonal 20 mm to fix LUXEON Star on metal heatsink, 132 pcs. per sheet of paper	K53-553-966

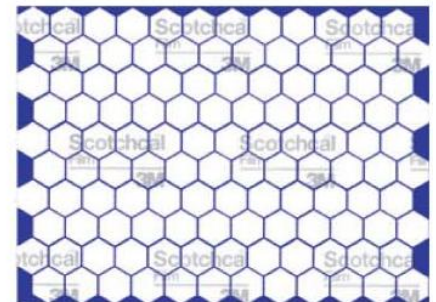
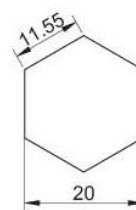

Optische Linsen für Seoul-, Luxeon I Power-LED auf hexagonaler Leiterplatte
Optical Lenses for Seoul- and Luxeon I Power-LED on hexagonal PCB

Durchmesser diameter	Höhe height	Typ type	Abstrahlwinkel beam angle	Artikel- nummer ref.-No.
35 mm	29 mm	spot narrow	13°	K53-574-431-00



Durchmesser diameter	Höhe height	Typ type	Abstrahlwinkel beam angle	Artikel- nummer ref.-No.
35 mm	29 mm	flood wide	45°	K53-574-432-00



Durchmesser diameter	Höhe height	Typ type	Abstrahlwinkel beam angle	Artikel- nummer ref.-No.
35 mm	29 mm	medium	23°	K53-574-433-00



Durchmesser diameter	Höhe height	Typ type	Abstrahlwinkel beam angle	Artikel- nummer ref.-No.
35 mm	14 mm	flood wide	40°	K53-553-428-00



Optische Linsen für Seoul-, Luxeon I Power-LED auf Leiterplatte
 Optical Lenses for Seoul- and Luxeon I Power-LED on PCB

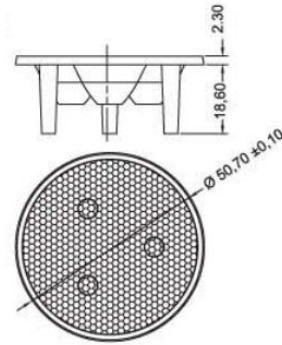

Abstrahlwinkel beam angle	Artikelnummer ref.-No.
25°	K53-553-441-00
45°	K53-553-442-00
60°	K53-553-443-00



Durchmesser diameter	Höhe height	Typ type	Abstrahlwinkel beam angle	Artikel- nummer ref.-No.
50 mm	29 mm	spot narrow	6°	K53-574-425-00



Durchmesser diameter	Höhe height	Typ type	Abstrahlwinkel beam angle	Artikel- nummer ref.-No.
50 mm	29 mm	flood wide	40°	K53-574-434-00



Durchmesser diameter	Höhe height	Typ type	Abstrahlwinkel beam angle	Artikel- nummer ref.-No.
50 mm	29 mm	medium	26°	K53-574-426-00

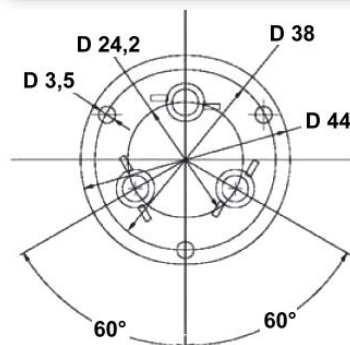

Aluminium-Leiterplatten und LED-Module mit Seoul-Power-LED Aluminium PCB and LED modules with Seoul Power-LED

mA
350

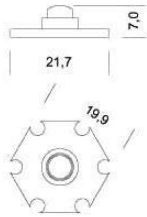
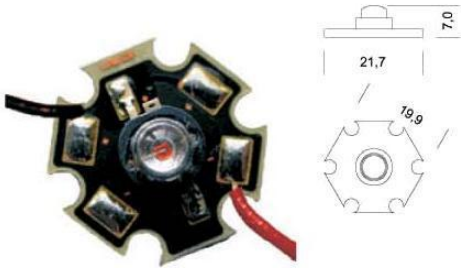

Anzahl LED LED quantity	Nennleistung rated power	Abstrahlwinkel beam angle	Verbindungen connections	Kabellänge cable length	Artikelnummer ref.-No.	Leuchtfarben fluorescent colour
1	1,3 W	140°		250 mm	K53-574-101-...	40 50 54 55 58 59 70

mA
350

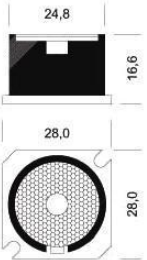

Anzahl LED LED quantity	Nennleistung rated power	Abstrahlwinkel beam angle	Verbindungen connections	Kabellänge cable length	Artikelnummer ref.-No.	Leuchtfarben fluorescent colour
1	1,3 W	10°		250 mm	K53-574-103-...	40 50 54 55 58 59 70

mA
350

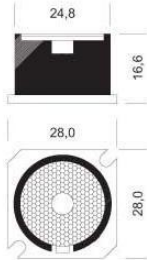

Anzahl LED LED quantity	Nennleistung rated power	Abstrahlwinkel beam angle	Verbindungen connections	Kabellänge cable length	Artikelnummer ref.-No.	Leuchtfarben fluorescent colour
1	1,3 W	30°		250 mm	K53-574-104-...	40 50 54 55 58 59 70

LED-Farbcodes: 40 = neutralweiß, 50 = hellweiß, 70 = warm weiß, 54 = blau, 55 = rot, 58 = gelb, 59 = grün

ACHTUNG: 350mA-LED's ausschließlich in Reihe schalten und nur empfohlene Versorger verwenden.

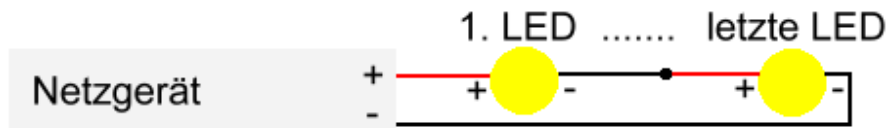

Rote Leitungen sind immer Plus
Schwarze Leitungen sind immer Minus

Weitere LED-Module und Leuchtenteile auf Anfrage erhältlich
More LED modules and components available on request